

NOTES:
 * OPEN
 ** SELECT IN TEST

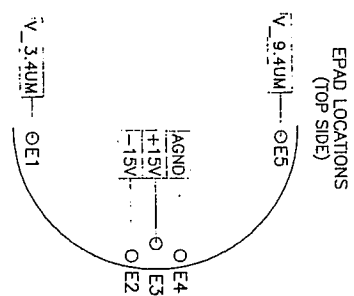

PWB ASSY, IR PREAMP, 18000
 021275FL REV F

PWB 310232D

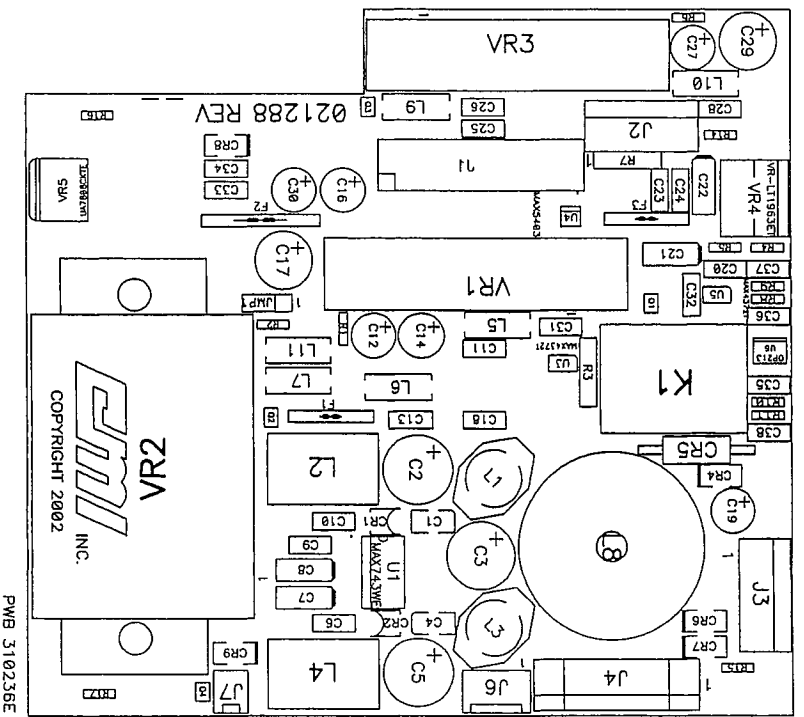

PWB 310236E

021288 REV
SMA

PMB
INC.
COPYRIGHT 2002

PWB ASST. POWER DISTRIBUTION, 18900
021288FL REV E

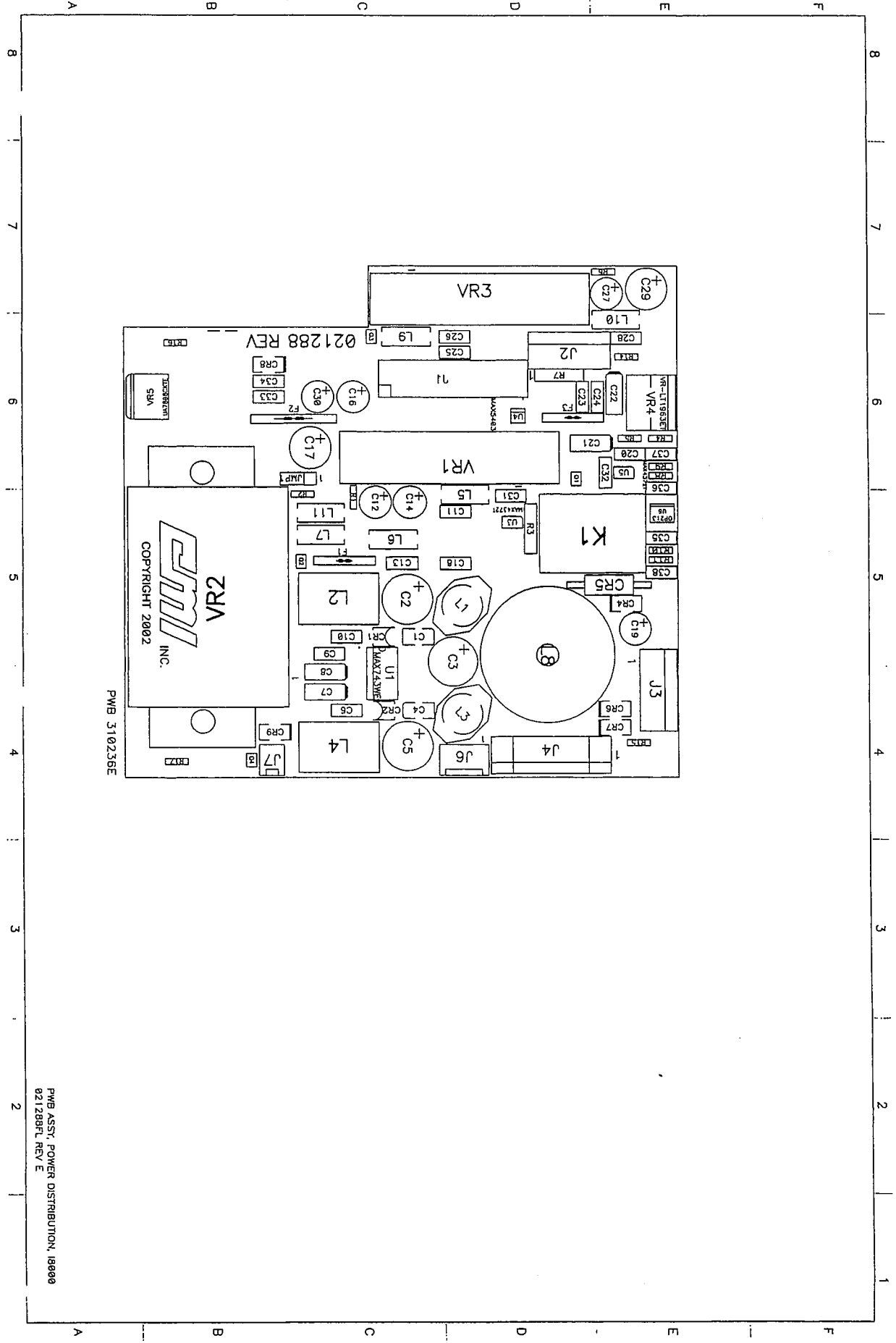

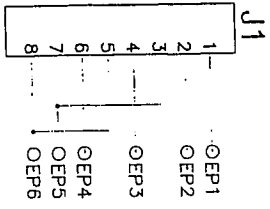

PWB 310238B

PWB ASSY, BRTH HOSE CONNECT, 18000
021308FL REV B

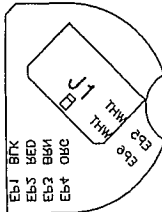
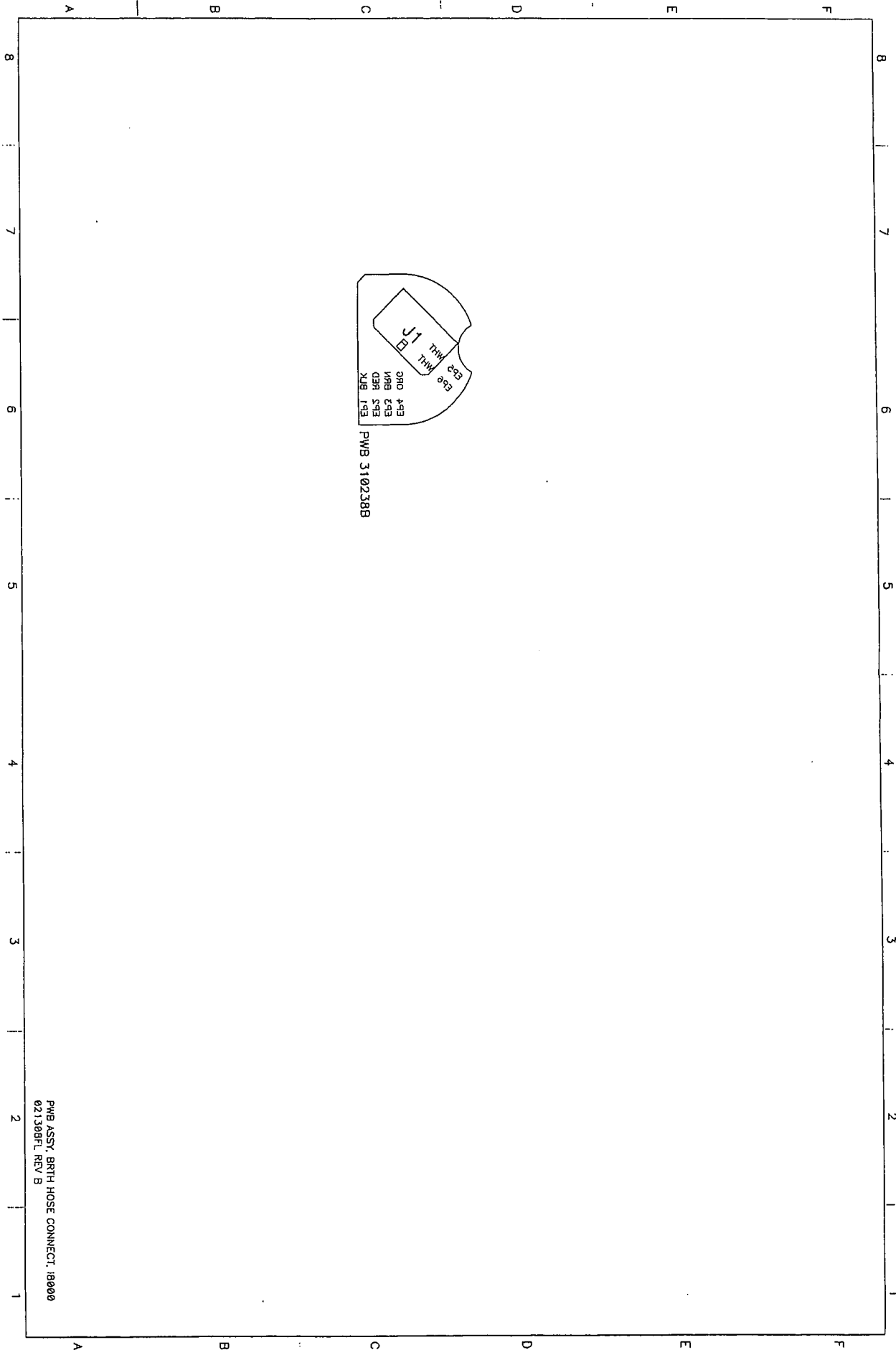

CHD +.03
IHD 2.33
IHD 2.33
IDH 5.93
IHD 1.93
PWB 310238B

PWB ASSY, BRTH HOSE CONNECT, 18000
021308FL REV B

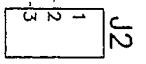
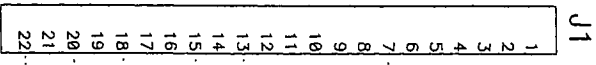

PWB ASSY, BREAKOUT, ANALOG IN, 18000
021454FL REV A

PWB 318241A

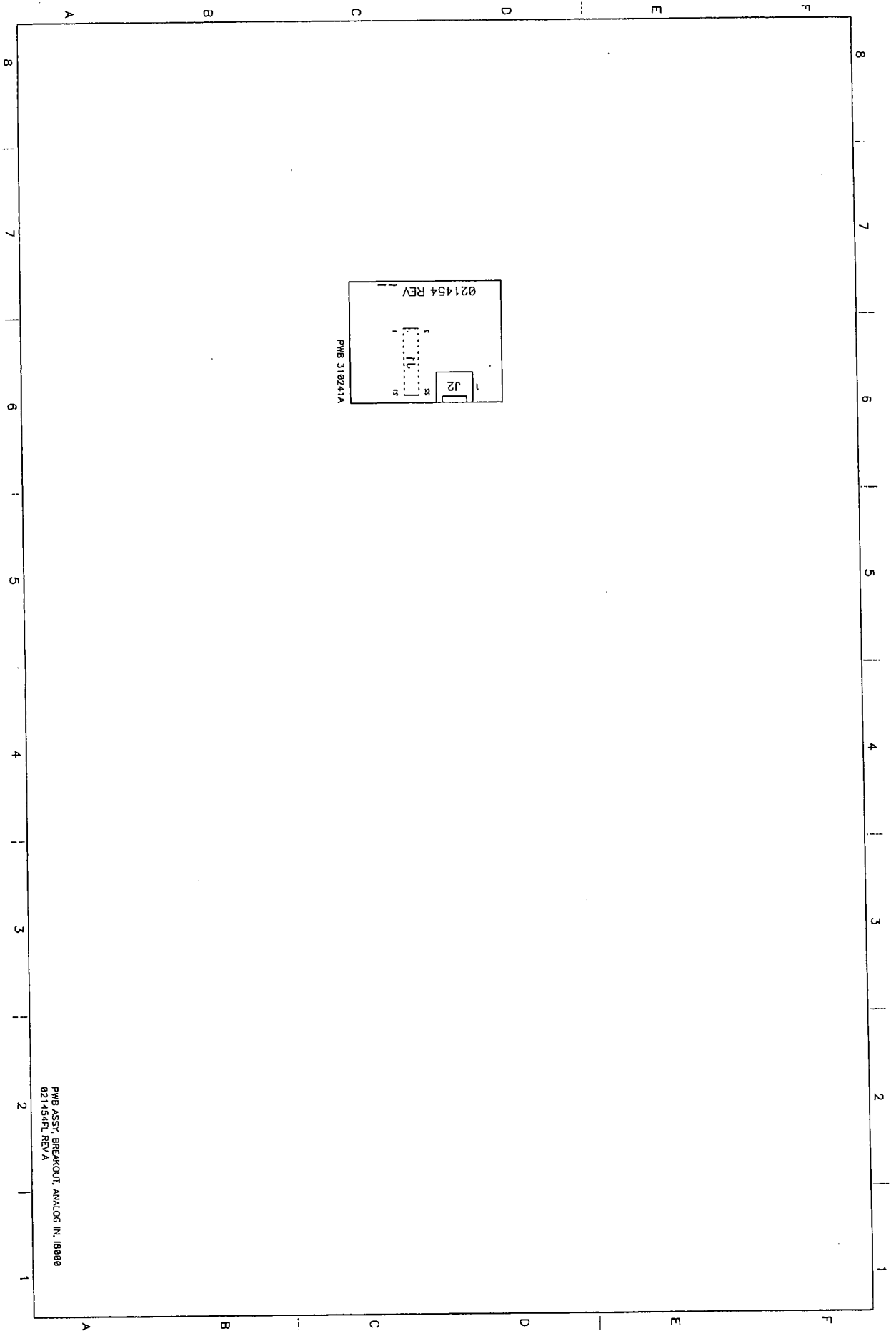

PWB ASSY BREAKOUT ANVLOG IN 18888
021454FL REV A

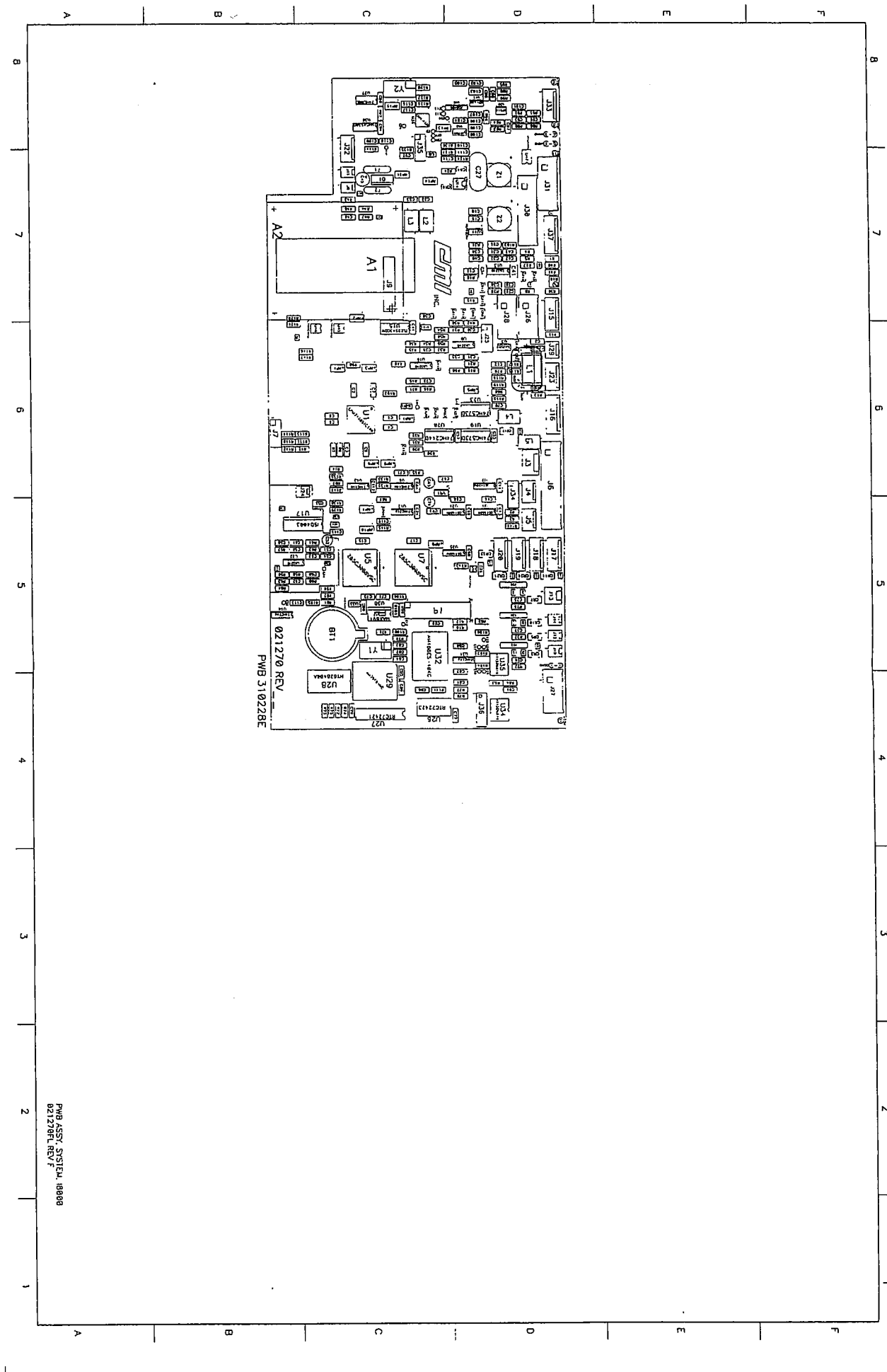

PMB ASSY SYSTEM 18888
021278FL REV F

PMB 310228E
021270 REV

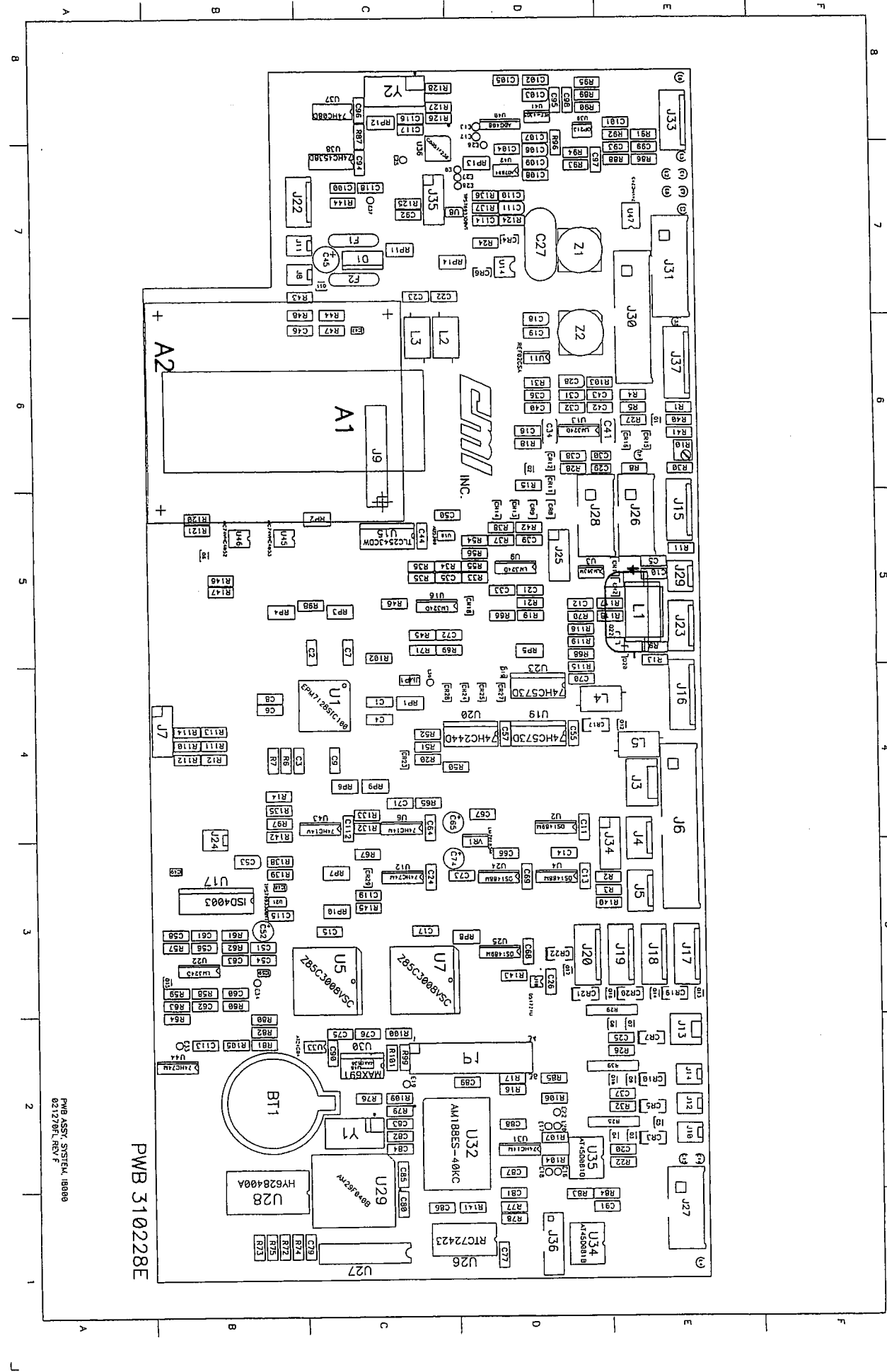

PWB 310228E

PWB ASSY. SYSTEM, 18000
021279FL REV F

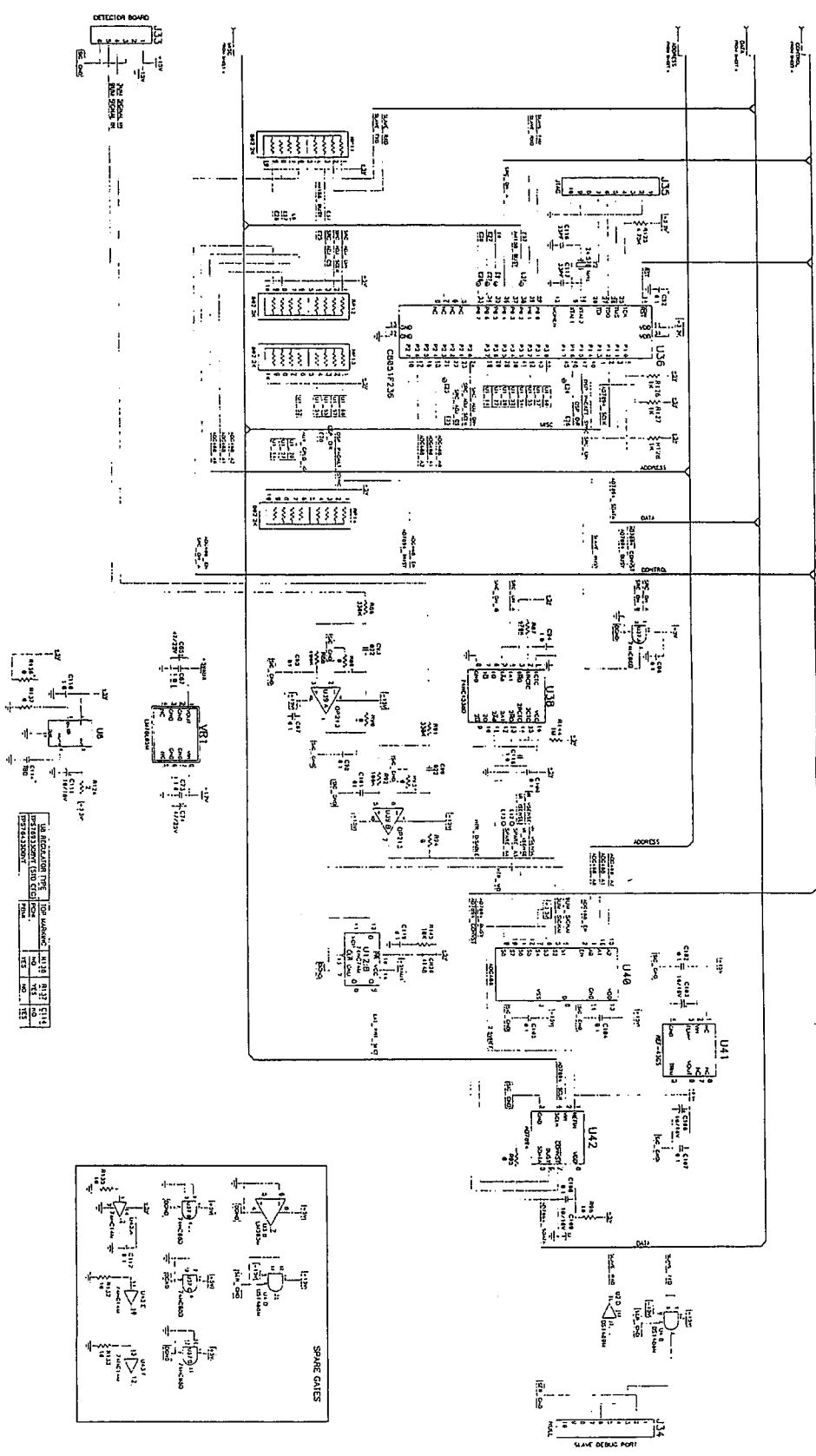

UNLESS OTHERWISE SPECIFIED
 2. ALL RESISTOR VALUES ARE IN OHMS UNLESS NOTED OTHERWISE

* THIS BOARD HAS BEEN REVISED
 * REV. 1.1, 1.2, AND 1.3 - ORIGINAL DESIGN

PWB ASSY. SYSTEM, 18000
 021278FL REV. F

END OF SHEET

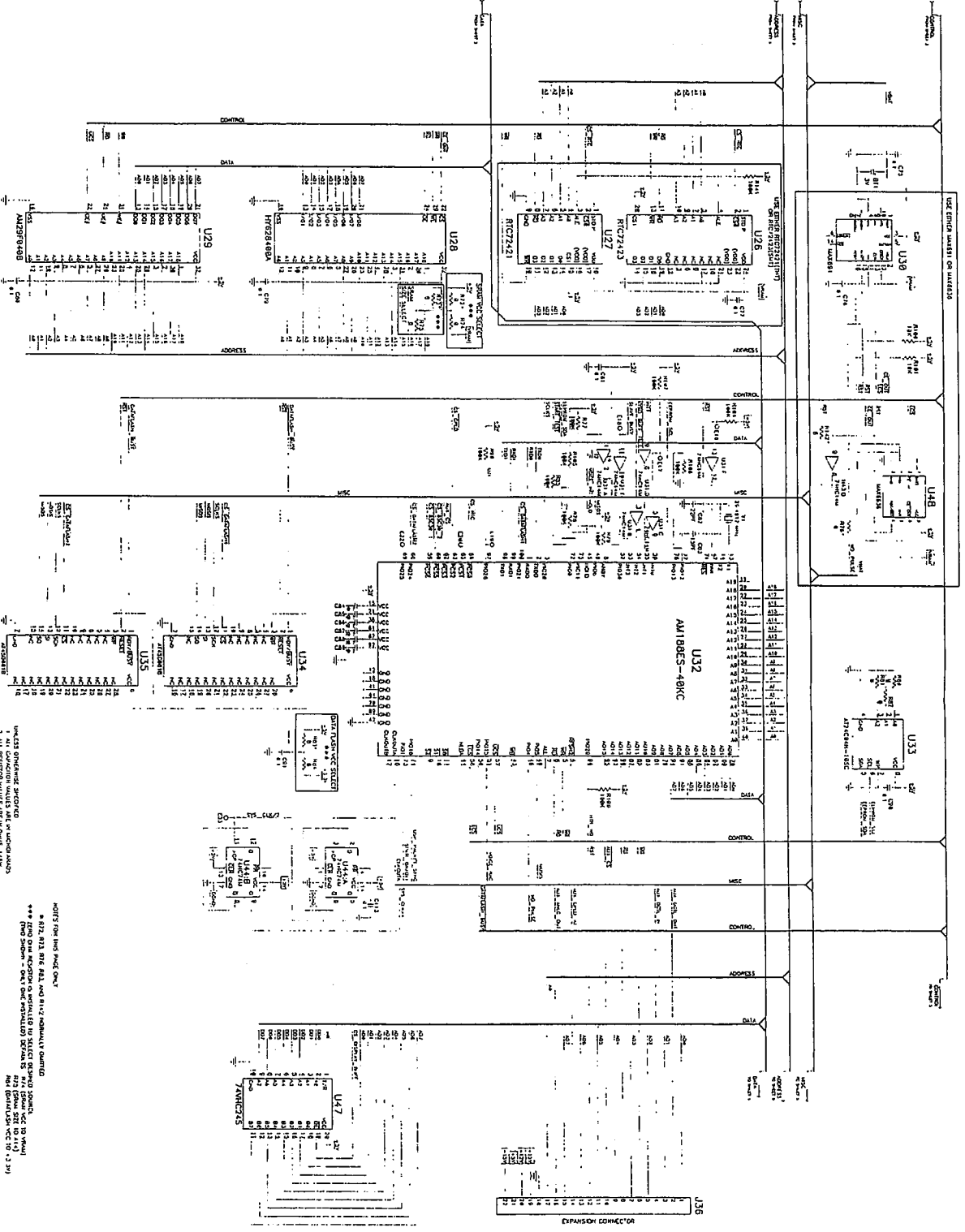

U26, U27, U28, U29, U30, U32, U33, U34, U35, U47, U48

NOTES FOR THIS PAGE ONLY
 * R170, R171, R172 AND R173 NORMALLY Omitted
 ** R170, R171, R172 AND R173 ARE Omitted TO SELECT OTHER BOARD SET TO 04/11
 *** R170, R171, R172 AND R173 ARE Omitted TO SELECT OTHER BOARD SET TO 04/11
 1- ALL RESISTORS IN THIS ARE IN OHMS, UNLESS SPECIFIED OTHERWISE

PWB ASSY SYSTEM, 18800
 021279FL REV F

PWB 021279FL

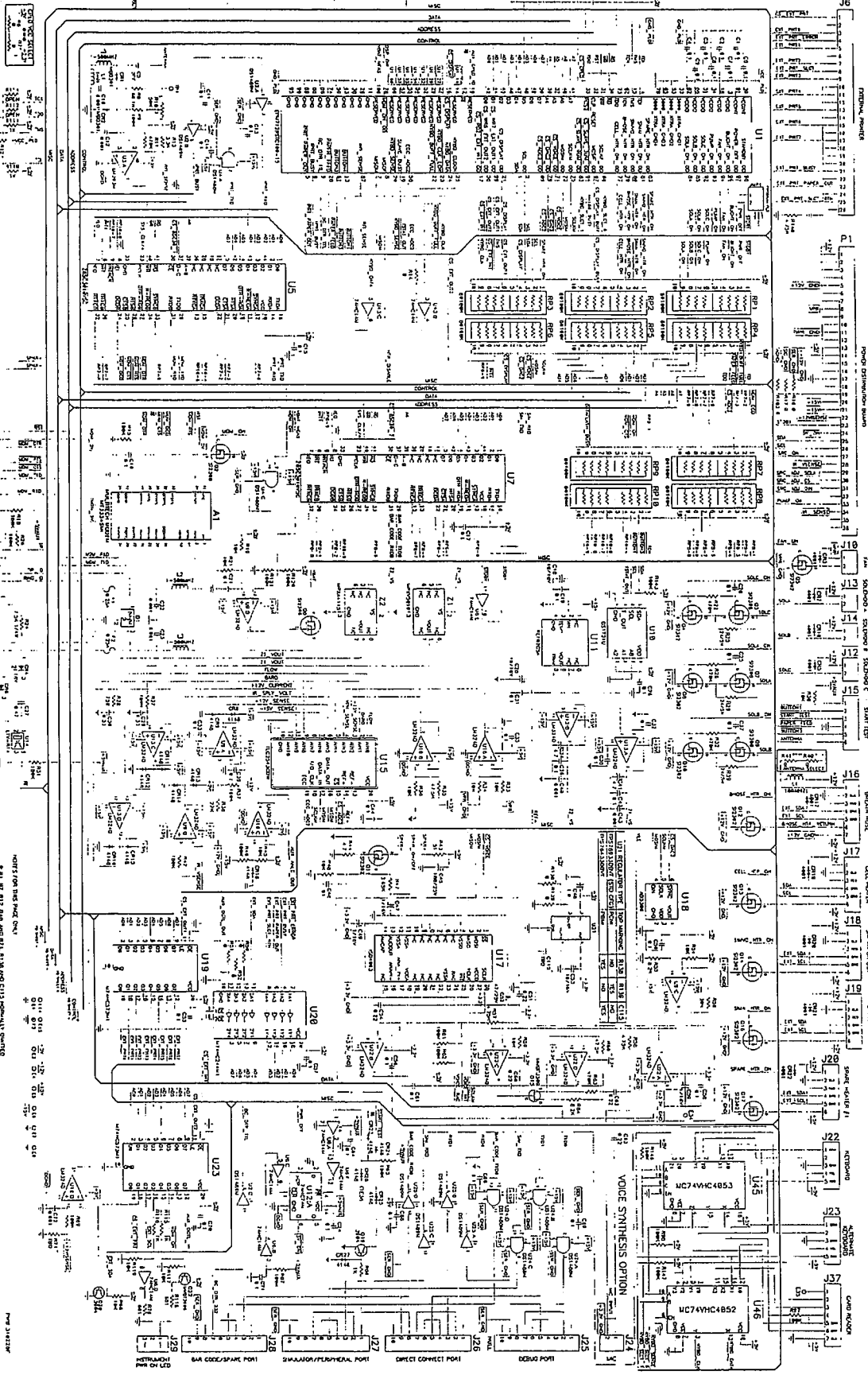
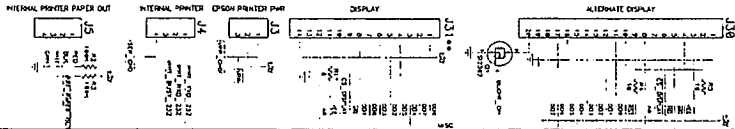

NOTES FOR THIS PAGE ONLY
 * A1 AT 412, A14, AND A15, A18 AND C115 ADJUSTMENT POINTS
 ** J17 AND J20 ARE NOT TO BE USED FOR THE VOICE SYNTHESIS OPTION
 *** J22 AND J23 ARE NOT TO BE USED FOR THE VOICE SYNTHESIS OPTION
 **** J21 AND J23 ARE NOT TO BE USED FOR THE VOICE SYNTHESIS OPTION
 ***** J21 AND J23 ARE NOT TO BE USED FOR THE VOICE SYNTHESIS OPTION

PCB ASSY. SYSTEM, 18888
 821278/F, REV. F

FIG. 115000

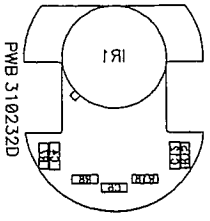
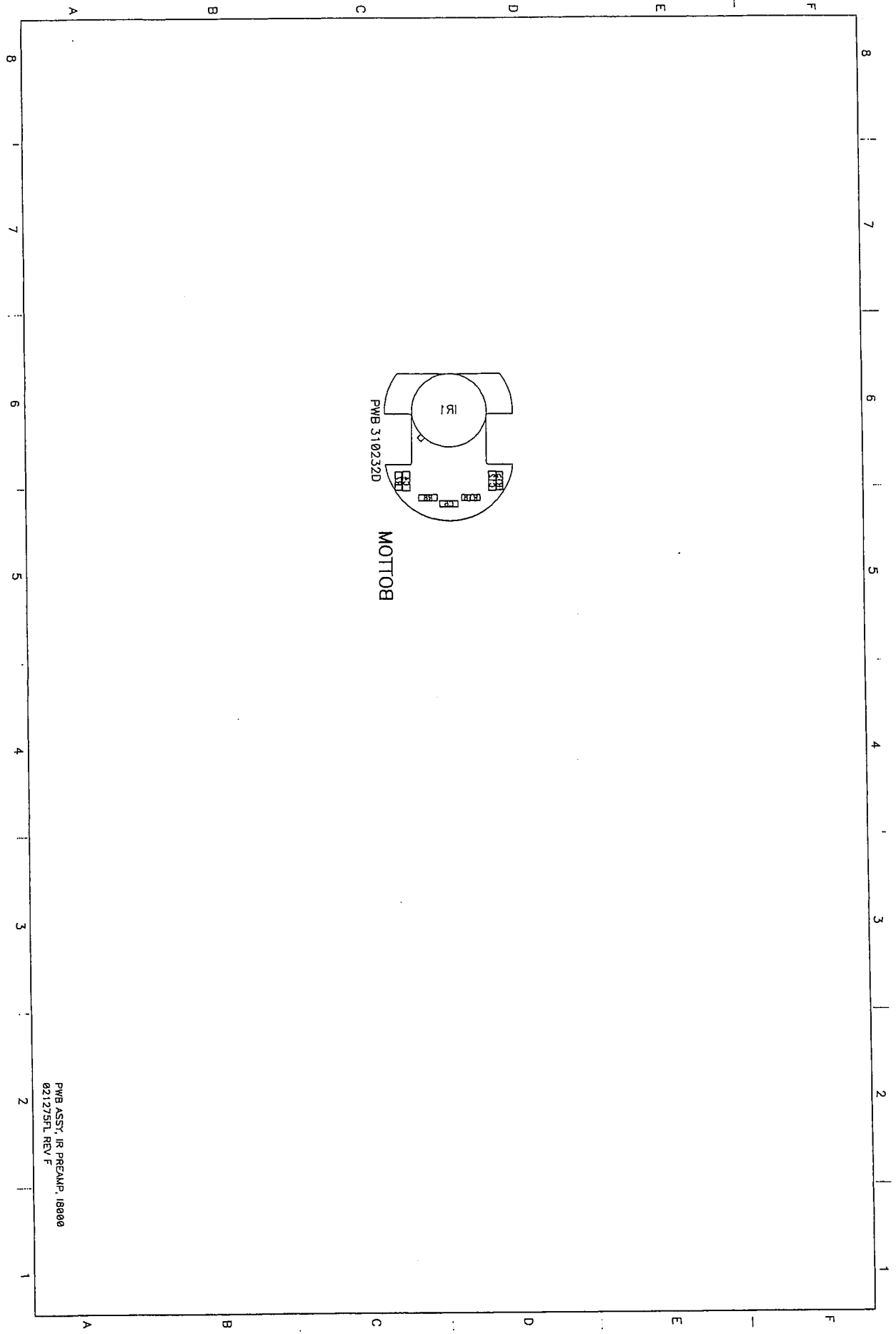

PWB 310232D

MOTTOB

PWB ASST. IR PREAMP. 18000
021275FL REV F

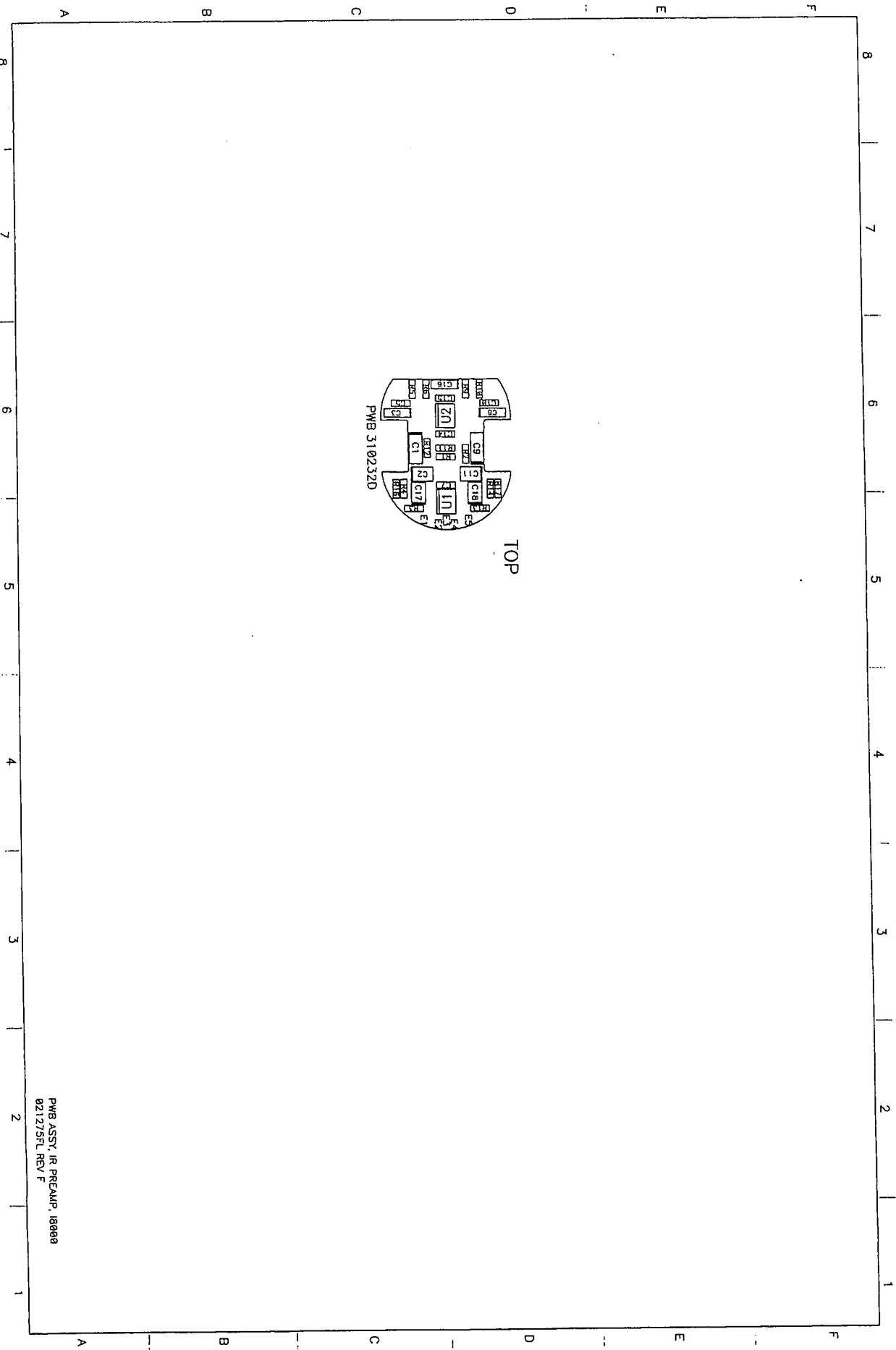

PWB 3102320

TOP

PWB ASST. IR PRECAMP, 18000
 021275FL REV F

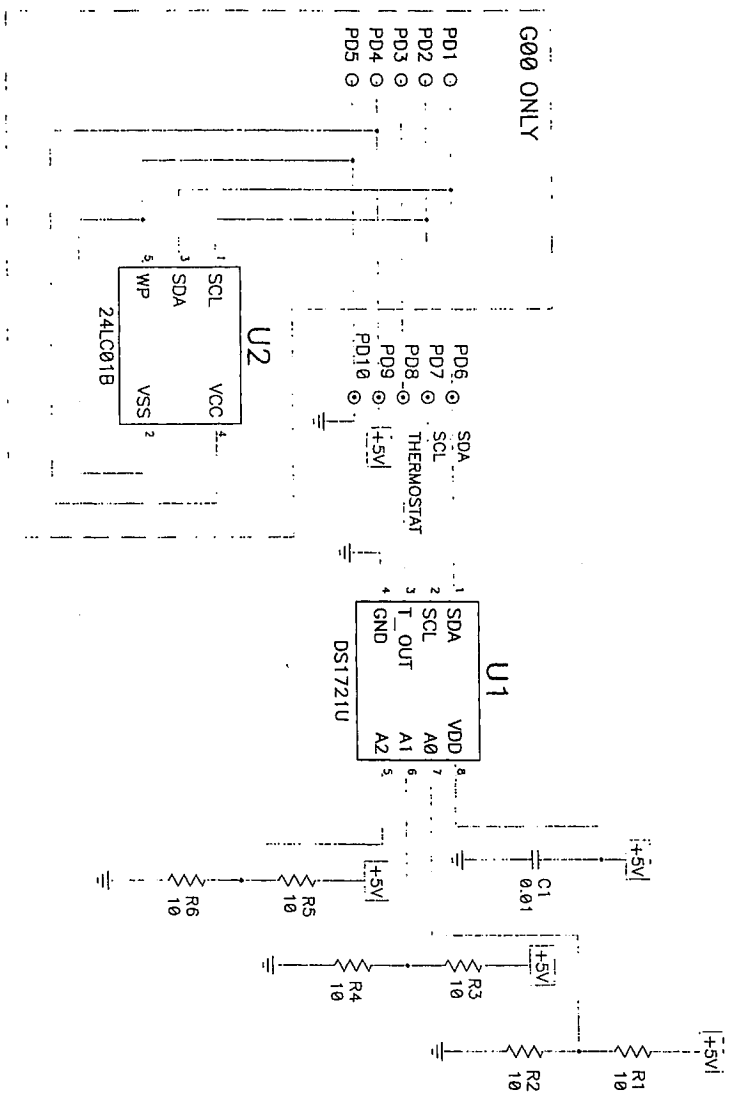

ADDRESS SELECTION

R1/R2	R3/R4	R5/R6	ADDRESS	GROUP
R2	R4	R6	0	G00
R1	R4	R6	1	G01
R2	R3	R6	2	
R1	R3	R6	3	
R2	R4	R5	4	
R1	R4	R5	5	
R2	R3	R5	6	
R1	R3	R5	7	

- UNLESS OTHERWISE SPECIFIED:
1. ALL CAPACITOR VALUES ARE IN MICROFARADS.
 2. ALL RESISTOR VALUES ARE IN OHMS

PWB 310235C

PWB ASSY, TEMP SENSOR, 18000
021287FL REV C

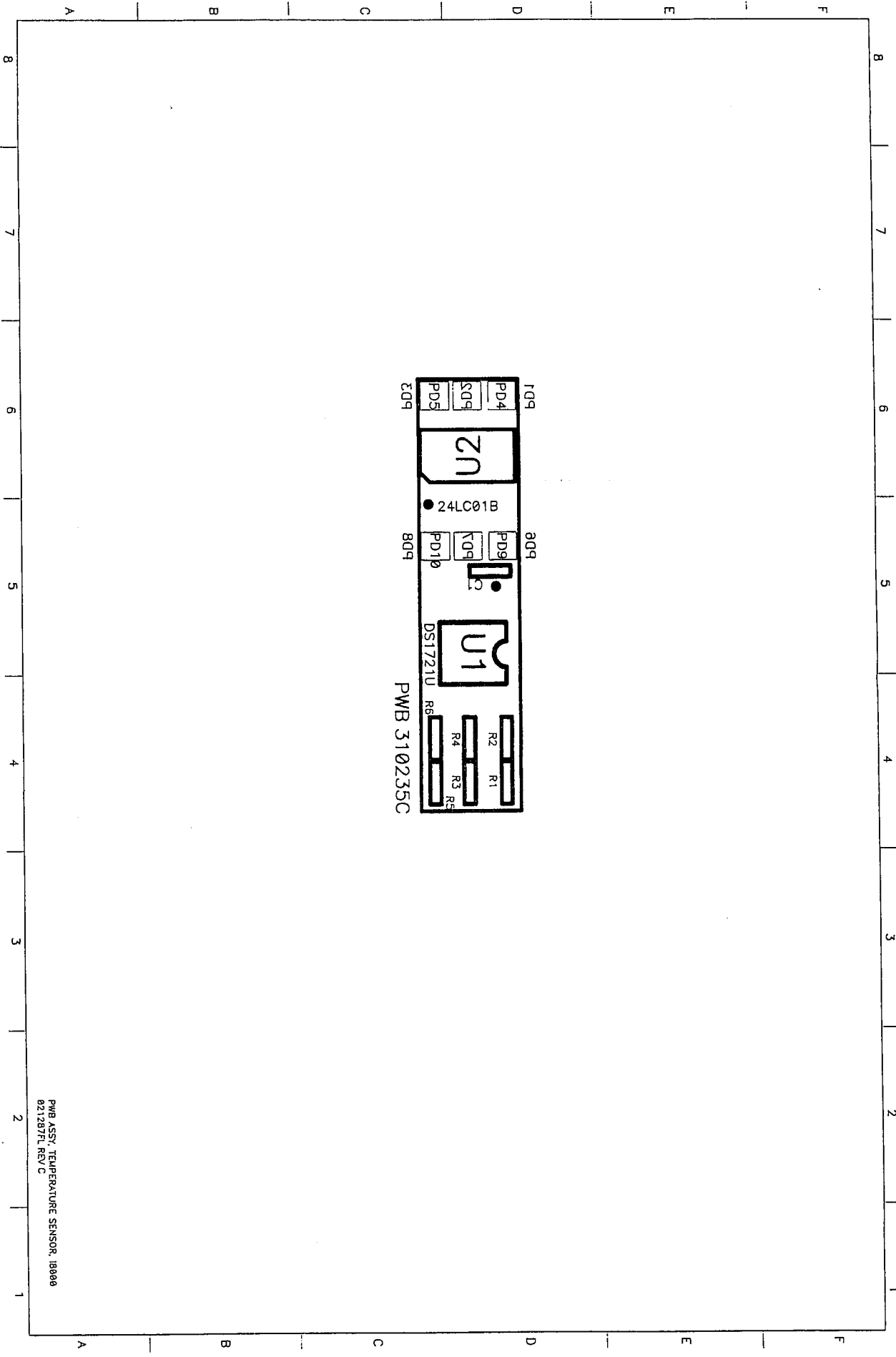

109 PD4 PD5
 2N
 24LC01B
 809 PD9 PD10 UQ9 UQ10
 DS1721U
 R1 R2 R3 R4 R5 R6
 PWB 310235C

PWB ASSY, TEMPERATURE SENSOR, 180000
 021287FL REV C

BATTERY PACK CTRL

SYSTEM BOARD

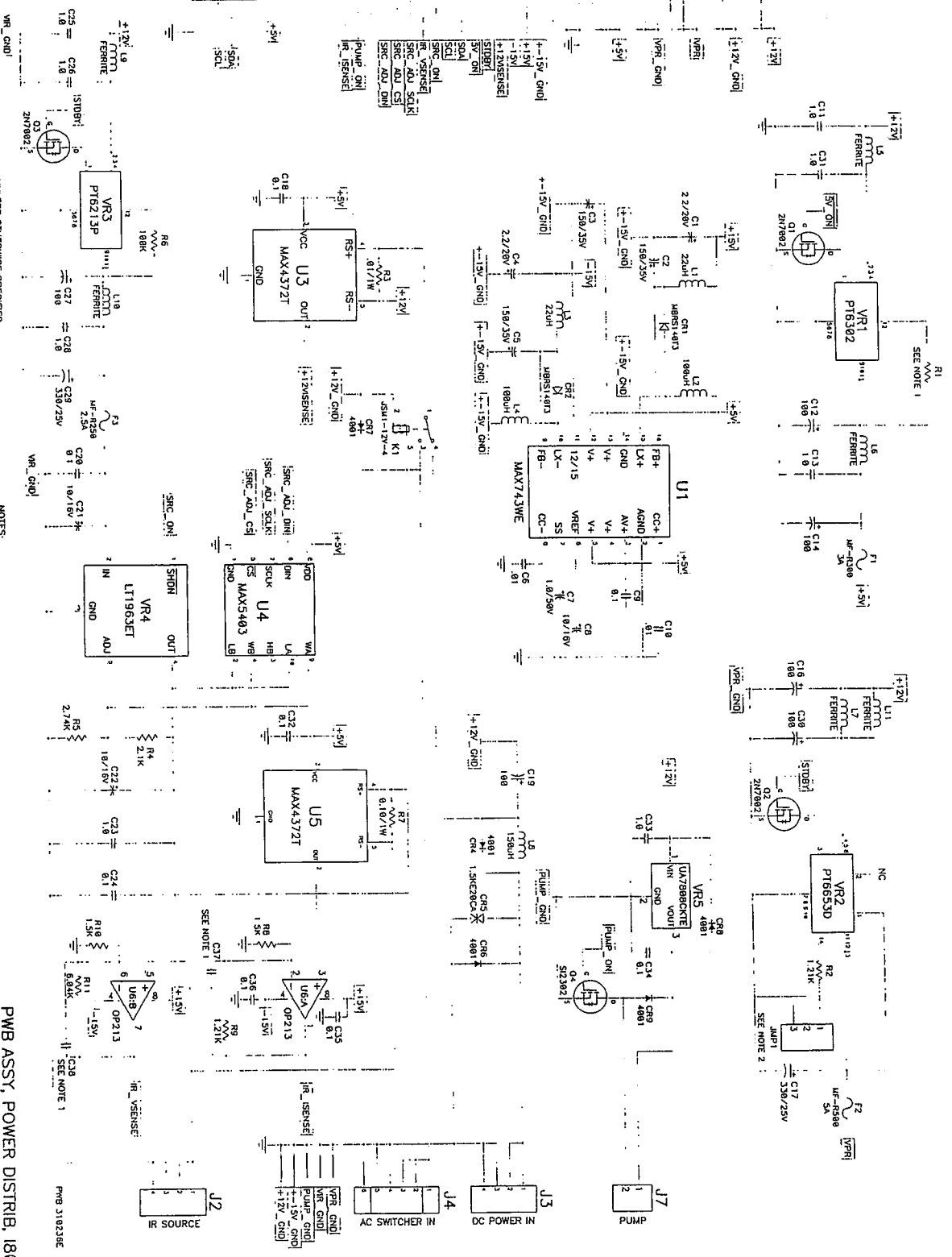

UNLESS OTHERWISE SPECIFIED:
 1. ALL CAPACITOR VALUES ARE IN MICROFARADS.
 2. ALL RESISTOR VALUES ARE IN OHMS

NOTES
 1. R1, C37, AND C38 OMMITTED IN STANDARD CONFIGURATION
 2. JUMPER ACROSS PINS 1 AND 2 OF AMP1 WITH THERMAL PRINTER OPTION.
 *JUMPER OPTION

PWB ASSY, POWER DISTRIB, 18000
 021288FL REV E

PWB 310238C